



USER MANUAL

DIGITAL TIMER

MECHATRON CALIBRATION AND INSTRUMENT

19/37, 2ND Main Road, Sabari Nagar, Mughalivakkam,
Chennai - 600116, Tamilnadu, India.

Phone : 9940060420 / 9962060420

Mail : info@mechatroncalibration.com

Website : www.mechatroncalibration.com



DIGITAL TIMER

DT-03 Series Multi-function Timer/Counter User's Manual



Features:

- With counting/length counting/timing function
- Dual line 6 digits LED display
- With up/down counting , timing function , 8 kinds of output modes
- Width of input signal can be selected
- Mounting depth is only 68mm , saving insalling space .

For your safe, please read the below content carefully before you use the timer/counter!

Safe Caution

* For your safe, please read the below content carefully before you use the timer/counter!

Please comply with the below important points:

- ⚠ Warning An accident may happen if the operation does not comply with the instruction.
 - ⚠ Notice An operation that does not comply with the instruction may lead to product damage.
- * The instruction of the symbol in the manual is as below:
⚠ An accident danger may happen in a special condition.

Warning

1. A safety protection equipment must be installed or please contact with us for the relative information if the product is used under the circumstance such as nuclear control, medical treatment equipment , automobile, train, airplane, aviation, entertainment or safety equipment, etc. Otherwise, it may cause serious loss, fire or person injury.
2. Apanel must be installed, otherwise it may cause creepage (leakage).
3. Do not touch wire connectors when the power is on, otherwise you may get an electric shock.
4. Do not dismantle or modify the product, If you have to do so, please contact with us first. Otherwise it may cause electric shock and fire.
5. Please check the connection number while you connect the power supply wire or input signal, otherwise it may cause fire.

Caution

1. This product cannot be used outdoors. Otherwise the working life of the product will become shorter, or an electric shock accident may happen.
2. When you connect wire to the power input connector or signal input connectors, the moment of the No.20AWG (0.50 mm²) screw tweaked to the connector is 0.74n.m-0.9n.m. Otherwise the connectors may be damaged or get fire.
3. Please comply with the rated specifications. Otherwise it may cause fire after the working life of the product becomes shorter.
4. Do not use water or oil base cleaner to clean the product. Otherwise it may cause electric shock or fire, and damage the product.
5. This product should be avoid working under the circumstance that is flammable, explosive, moist, under sunshine, heat radiation and vibration.
6. In this unit it must not have dust or deposit, otherwise it may cause fire or mechanical malfunction.
7. Do not use gasoline, chemical solvent to clean the cover of the product because such solvent can damage it. Please use some soft cloth with water or alcohol to clean the plastic cover.

1. Code illustration

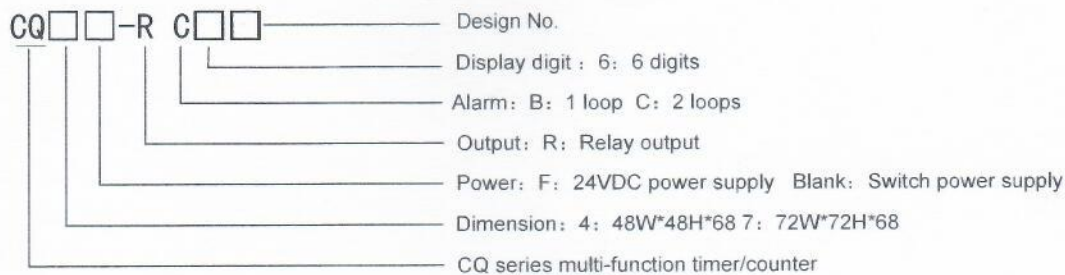

2. Ordering Code

S/N	Code	Panel Size (mm)	LED Display Digit	Alarm Output
1	CQ7-RC60	72H×72W	6 digits	2
2	CQ7-RB60	72H×72W	6 digits	1
3	CQ4-RC60	48H×48W	6 digits	2
4	CQ4-RB60	48H×48W	6 digits	1

3. Technical Specification

Product series		CQ Series timer/counter
Display digit		Dual lines of 6-digit LED
Rated voltage		AC 85-265VAC 50/60Hz
Allowable voltage floating range		90%-110% of Rated voltage (AC)
Counting speed		1cps,30cps,1kcps,5kcp
Input pulse width	counter	Reset input:select 1ms or 20ms
	Timer	CP1,CP2,PAUSE,EXTERNAL_RESET select 1ms or 20ms
Input		Residual voltage: Max 2V DC Open-circuit impedance: Min 100KΩ voltage input:input impedance 5.4KΩ,"H": 5-30VDC "L":0-2VDC Selectable voltage input or No-voltage input No-voltage input:Short-circuit impedance: Max 1KΩ,
Delay time	Counter	0.01-9999.99S selectable
	Timer	0.01-9999.99S selectable
Control output	Contacts capacity	NO:250VAC 3A impedance NC: 250VAC 2A impedance
	Solid State Relay capacity	Max 30VDC , Max 100mA
Memory time		10 years
Auxiliary power		12VDC±10% Beblow100mA
Ambient Temperature		-10℃~50℃ (Non-freezing)
Store temperature		-25℃~65℃ (Non-freezing)
Ambient Humidity		35-85%RH
Time Accuracy		Power On: ±0.01%±0.05sec Start signal: ±0.01%±0.03sec
Insulation resistance		Min 100MΩ (at 500V DC)
Dielectric strength		2000V DC 50/60Hz 1 min
Anti-interference(AC Power)		±2kV interferenced by square wave generator (Pulse width:1us)
Vibration	Mechanical	Amplitude: 0.75mm Frequency:10to 55Hz each dirction of X,Y,Z for 1hour
	Malfunction	Amplitude: 0.5mm Frequency:10to 55Hz each dirction of X,Y,Z for 10 min
Life Span	Mechanical	Above 10,000,000 times
	Electric	Above 100,000 times (NO:250VAC 3A load NC:250VAC 2A load)

4. Panel Indication

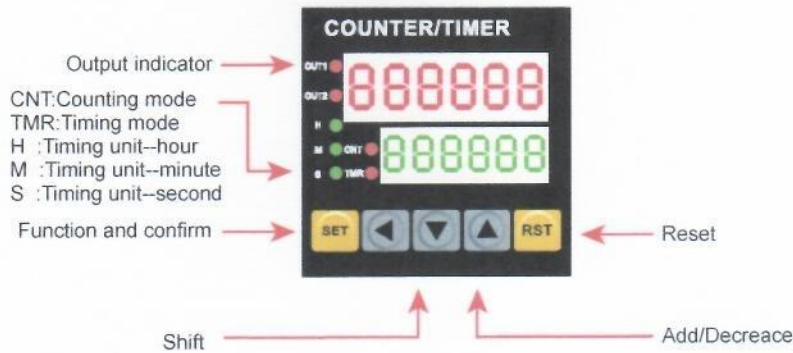

5. Operation process

5.1. How to change the preset value of timing/counting

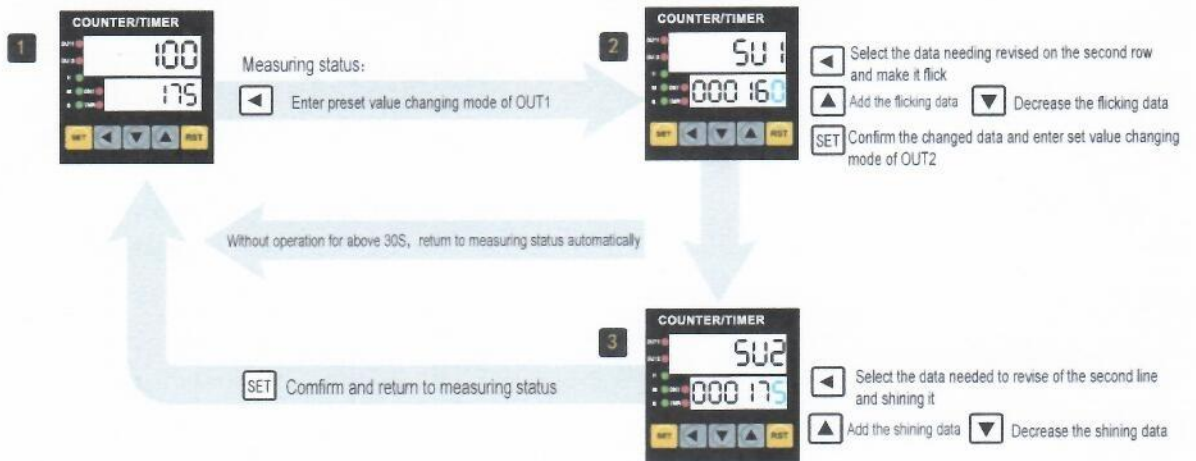

* If preset value isn't set as (SU1 <= SU2), it will display Error, please reset it.

* If lock menu (LOCK) select LOC.2 or LOC.3, preset value changing mode couldn't be entered.

* If enter the preset value changing mode, don't operate for above 30s, it will return to measuring status automatically, all the changed value wouldn't be saved.

5.2 How to enter function menu

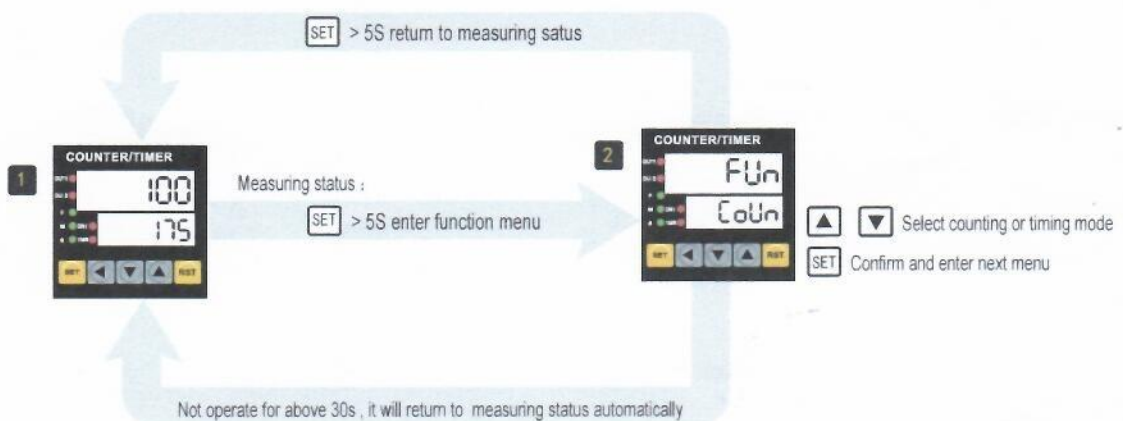

* If lock menu (LOCK) is set as LOC.1 or LOC.2 mode, the menu can just be reviewed, and couldn't be changed.

* If enter the changing mode of function menu, press (SET) for 5s return to measuring status, both display value and output will be reset.

* If enter the changing mode of function menu, and not operate for 30s, it will return to measuring status and all the changed data wouldn't be saved.

6. Time function mode setting

Menu	Selection ▲ ▼	Original setting value
Counting/Timing (FUN)	Count → Time Count : Counting Time : Timing	Time
Time Range	SEC 9999.99 SEC 99999.9 SEC 9999999 mS 99.59.99 mS 999.59.9 Hm 9999.59 Hm 99.59.59 9999999 99999.9	9999.99
Up/Down Mode (U-d)	U → d Up: Time from 0 (ZERO) to the setting value Down: Time from setting value to 0 (ZERO)	U
Output Mode (OUT)	F → n → C → r → e → P → 9 → A	C
Output Time (OUT.t)	<input type="checkbox"/> Select the need revised data of the below line and shining it <input type="checkbox"/> Add the shining data <input type="checkbox"/> Decrease the shining data Time delay range: 0.01-9999.99s	0002.00
Input logic (S.G)	nPN → PnP NPN or PNP input	PnP
signal input time (int)	1 → 20 CP1, CP2, RESET, PAUSE, the min pulse width of signal (ms)	1
Save the counting value (Hold)	YES → no YES: Power off Save the counting value NO: Power off Counting reset	YES
Lock key (Lock)	LoFF → LoC.1 → LoC.2 → LoC.3 LoFF : Cancel lock status LoC.1 : Lock [RST] key LoC.2 : Lock [←] [↑] [↓] key LoC.3 : Lock [RST] [←] [↑] [↓]	LoFF

7. Time Range

Time Range	Function Setting	
	Unit Indication	Range Indication
0.01s~9999.99s	SEC	9999.99
0.1s~99999.9s	SEC	99999.9
1s~999999s	SEC	999999
0.01s~99m59.99s	mS	99.59.99
0.1s~999m59.9s	mS	999.59.9
0.1m~99999.9m	m	99999.9
1m~999999m	m	999999
1s~99h59m59s	HmS	99.59.59
1m~9999h59m	Hm	9999.59

8. Setting the function mode of counter

Mode Setting		Selection setting (▼, ▲)	
<div style="display: flex; flex-direction: column; align-items: center; gap: 10px;"> <div style="border: 1px solid black; padding: 2px;">SET</div> <div style="border: 1px solid black; padding: 2px;">SET</div> <div style="border: 1px solid black; padding: 2px;">SET</div> <div style="border: 1px solid black; padding: 2px;">SET</div> <div style="border: 1px solid black; padding: 2px;">SET</div> <div style="border: 1px solid black; padding: 2px;">SET</div> <div style="border: 1px solid black; padding: 2px;">SET</div> <div style="border: 1px solid black; padding: 2px;">SET</div> <div style="border: 1px solid black; padding: 2px;">SET</div> <div style="border: 1px solid black; padding: 2px;">SET</div> <div style="border: 1px solid black; padding: 2px;">SET</div> <div style="border: 1px solid black; padding: 2px;">SET</div> </div>	Counting/Timing (FUN)	 CoUn: Counter t.nE : Timer	CoUn
	Input Mode (In)		b
	decimal point (dP)		---
	Preset (P)	<input type="checkbox"/> Select the need revised data of the below line and shining it <input checked="" type="checkbox"/> Add the shining data <input type="checkbox"/> Decrease the shining data Value setting range of P: 0.001-99.999(The real quantity of a pulse)	01.000
	Max counting speed (CP)		5E
	Output mode (out)		C
	Delay time (out.t)	<input type="checkbox"/> Select the need revised data of the below line and shining it <input checked="" type="checkbox"/> Add the shining data <input type="checkbox"/> Decrease the shining data Delay range: 0.01-9999.99s	0002.00
	Input logic (S.G)	 Be used to select the output type of sensor :NPN or PNP	nPn
	Min reset time (rst)	 Min pulse width of RESET、PAUSE signal (ms)	1
	Counting value saving (Hold)	 YES : Power off Save counting value NO : Power off Reset counting value	YES
	Lock key (LoCk)	 LoFF : Cancel lock LoC.1 : Lock <input type="checkbox"/> key LoC.2 : Lock <input type="checkbox"/> <input type="checkbox"/> <input type="checkbox"/> LoC.3 : Lock <input type="checkbox"/> <input type="checkbox"/> <input type="checkbox"/>	LoFF

9. Input mode of counter

Input mode	Counting graph	Remark
A-U (Up)		CP1: Counting input CP2: Inhibit Counting input (The counting input is influenced by CP1) When CP1 is L, Setting for inhibit counting (CP2: L changes to H) Release inhibit counting (CP2: H changes to L)

Input Mode	Counting graph	Remark
A-U (Up)		CP2: Counting input CP1: Inhibit counting input (Counting input is limited by CP2) When CP2 set to H, Setting for inhibit counting (CP1: H changes to L) Release counting inhibit (CP1: L changes to H)
A-D (Down)		CP1: Counting input CP2: When n=setting value, inhibit counting input (the counting input is limited by CP1) When CP1 set to L, Setting for inhibit counting (CP2: L set to H) Release counting inhibit (CP2: H set to L)
		CP2: Counting input CP1: When n=setting value, inhibit counting input (the counting input is limited by CP2) When CP2 set to H, Setting for counting inhibit (CP1:H changes to L) Release counting inhibit (CP1:L changes to H)
B (Up/Down-A) Order input		CP1: Counting input CP2: Up/Down order input When the signal of CP2 is L, counting up When the signal of CP2 is H, counting down
C (Up/Down-B) separate input		CP1: Up counting input CP2: Down counting input CP1 and CP2 change from L to H at the same time, the former counting status will keep.
D (Up/Down-C) Phase difference input		When phase A、phase B of encoder connect with CP1、CP2, this function could be used

* (A) : Above the width of min signal (B) : Above the half of min signal width

* When output from phase A and phase B of encoder input to CP1 and CP2, please set phase difference mode D of the counter

Sign \ Input type	Voltage input (PNP)	No-voltage input (NPN)
H	5-30VDC	Short circuit
L	0-2VDC	Open circuit

10. Output action mode of counter

	Input mode		Action for counting /timing when it reaches to the setting value
	Up	Down	
F			Display keeps up or down , output maintain till reset signal input
N			Both display and output maintain till reset signal input .
C			Display vale return to the beginning status automatically ,output won't return to the beginning untill it reaches to the settet delay time (Output action is repeated)
R			Both display value and output maintain till it reaches to the settet delay time then return to the beginning status . (Output action is repeated)
K			Display value keeps up or down till reset signal input , output won't return to the beginning status until it reaches the settet delay time . (Output action is repeated)
P			Display value maintains till the delay time output , then display the value of next round .(Counting/Timing of next round starts from the beginning value during the delay time) (Output action is repeated)
Q			Display value keep up or down during the output delay time , when it comes to the settet delay time,both the display value and output will return to the beginning status. (Output action is repeated)
A			Display value and output of OUT1 keep till reset signal input .OUT2 return to the beginning status when it reaches to the output delay time .

11. Input connection

1. Input logic: No-voltage input (NPN)

(1) Solid state relay input

● Standard sensor: NPN output sensor

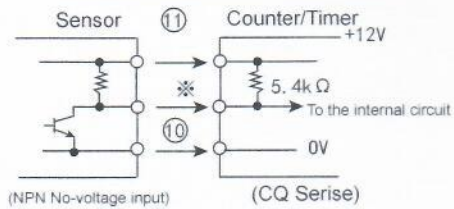

(2) Contacts connecting in Counter/Timer

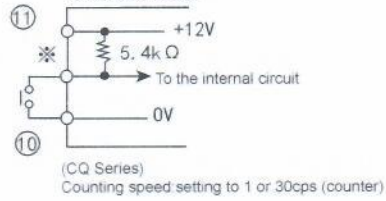

2. Input logic: voltage input (PNP)

(1) Solid state relay input

● Standard sensor: PNP output sensor

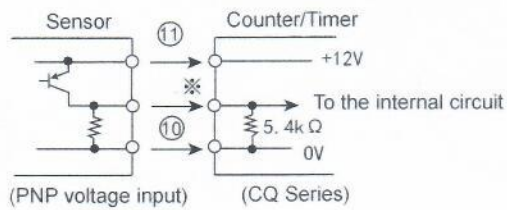

(2) Contacts connecting in Counter/Timer

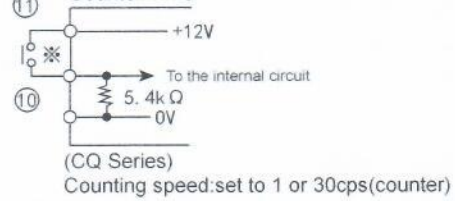

12. Connecting Drawing

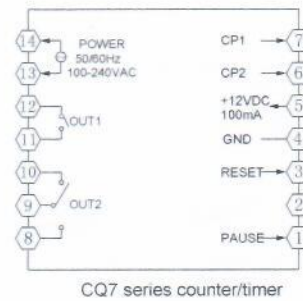
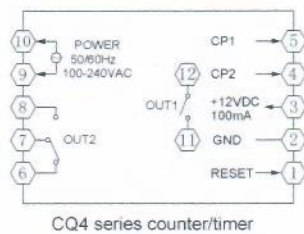

Note: Please subject to the connecting drawing on the actual meter if any changes

13. Dimension (mm)

